

Tous droits strictement réservés. Reproduction ou communication a des tiers interdite sous quelque forme que ce soit sans autorisation écrite du propriétaire. Propriété de c FCI. Droits de reproduction FCI.

All rights strictly reserved. Reproduction or issue to third parties in any form whatever is not permitted without written authority from the proprietor. Property of FCI. Copyright FCI.

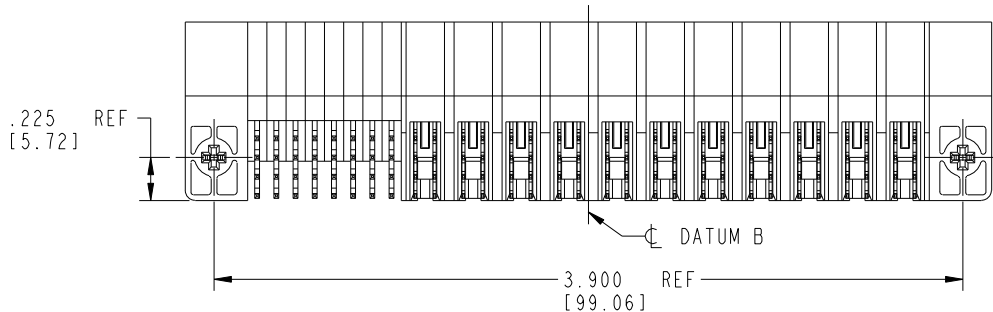
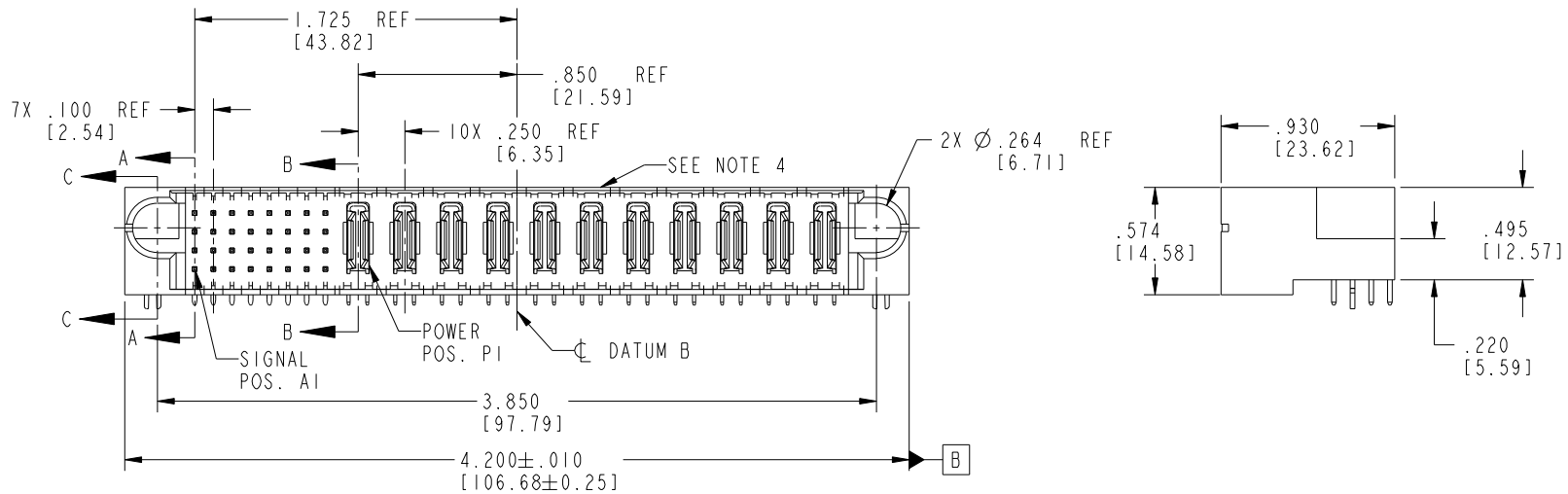
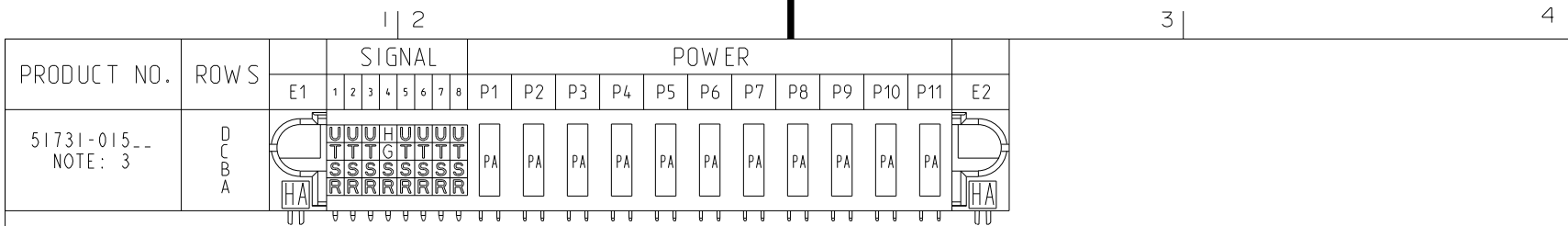

CODE	DIM "M" MATING LENGTH	CONTACT TYPE
G	.220 [5.59]	SIGNAL
H	.220 [5.59]	SIGNAL
R	.270 [6.86]	SIGNAL
S	.270 [6.86]	SIGNAL
T	.270 [6.86]	SIGNAL
U	.270 [6.86]	SIGNAL
PA	N/A [N/A]	POWER
HA	N/A [N/A]	HOLD-DOWN

mat'l code				SEE NOTE 2		tolerances unless otherwise specified		CUSTOMER		 www.fciconnect.com		
ltr	ecn no.	dr	date	linear	.XX±.01/0.X±0.3		COPY		title			
A	V03-0090	TAB	01/21/03		.XXX±.005/0.XX±0.13		projection		32S + 11P			
B	V03-0956	MEM	8/27/03	angles	.XXX±.0020/0.XXX±0.051				RIGHT ANGLE SOLDER HEADER			
C	V04-0915	TAB	09/17/04		0°±2°				product family			
D	V04-1133	TAB	12/01/04	dr	T. BRUNGARD	01/21/03	INCH/MM		PwrBlade		code	
E	DG05-0458	GuoJM	11/19/05	engr	M. MOSTOLLER	01/21/03	scale		size		213	
F	DG06-0367	JMG	09/07/06	chr	M. MOSTOLLER	01/21/03	1:1		dwg no		sheet	
sheet index				revision	F	F			A		51731-015	1 of 4
				sheet	1	2						

Pro/E

PDM: Rev:F

STAT: Released

Printed: Aug 17, 2007

Tous droits strictement réservés. Reproduction ou communication a des tiers interdite sous quelque forme que ce soit sans autorisation écrite du propriétaire. Propriété de c FCI. Droits de reproduction FCI.



All rights strictly reserved. Reproduction or issue to third parties in any form whatever is not permitted without written authority from the proprietor. Property of FCI. Copyright FCI.

PRODUCT NUMBER
51731-015__
NOTE: 3

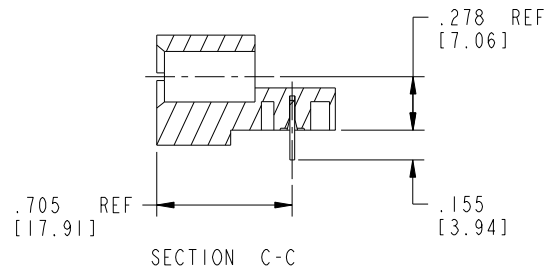
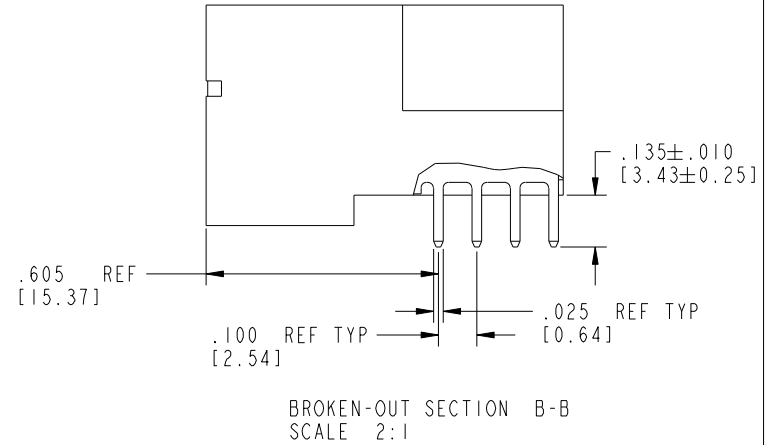
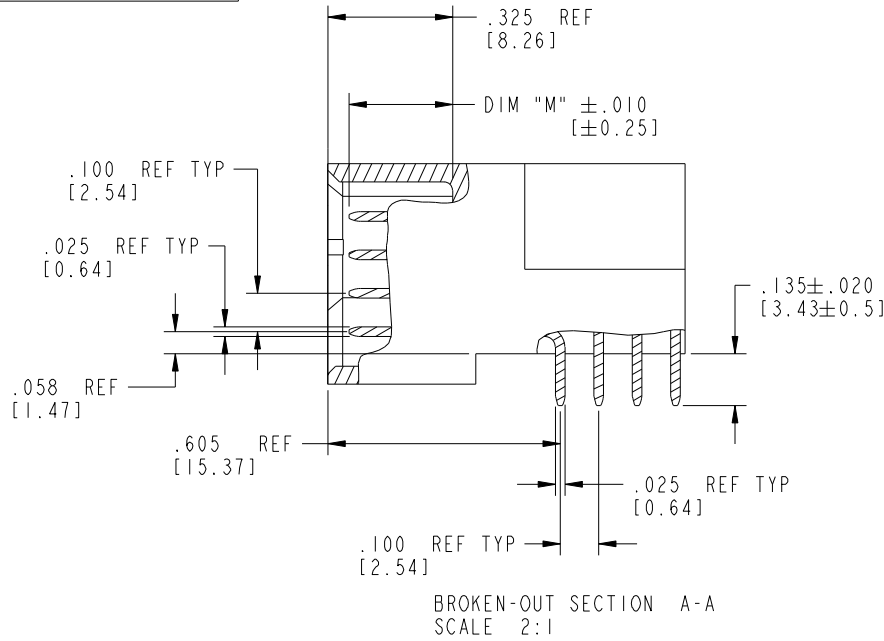

mat'l code		SEE NOTE 2		tolerances unless otherwise specified		CUSTOMER		FCI	
lbr	ecn no.	dr	date	linear	.XX±.01/0.X±0.3	COPY		www.fciconnect.com	
F				projection	.XXX±.005/0.XX±0.13			title 32S + 11P	
				angles	.XXX±.0020/0.XXX±0.051			RIGHT ANGLE SOLDER HEADER	
				dr	0°±2°	INCH/MM		product family PwrBlade	
				enr	T. BRUNGARD 01/21/03	scale 1:1		code 213	
				enr	M. MOSTOLLER 01/21/03			size dwg no	
				chr	M. MOSTOLLER 01/21/03			A 51731-015	
				appd	M. MOSTOLLER 01/21/03			sheet 2 of 4	
sheet index	revision sheet								

Pro/E

PDM: Rev:F

STATUS: Released

Printed: Aug 17, 2007

Tous droits strictement réservés. Reproduction ou communication a des tiers interdite sous quelque forme que ce soit sans autorisation écrite du propriétaire. Propriété de c FCI. Droits de reproduction FCI.



All rights strictly reserved. Reproduction or issue to third parties in any form whatever is not permitted without written authority from the proprietor. Property of FCI. Copyright FCI.

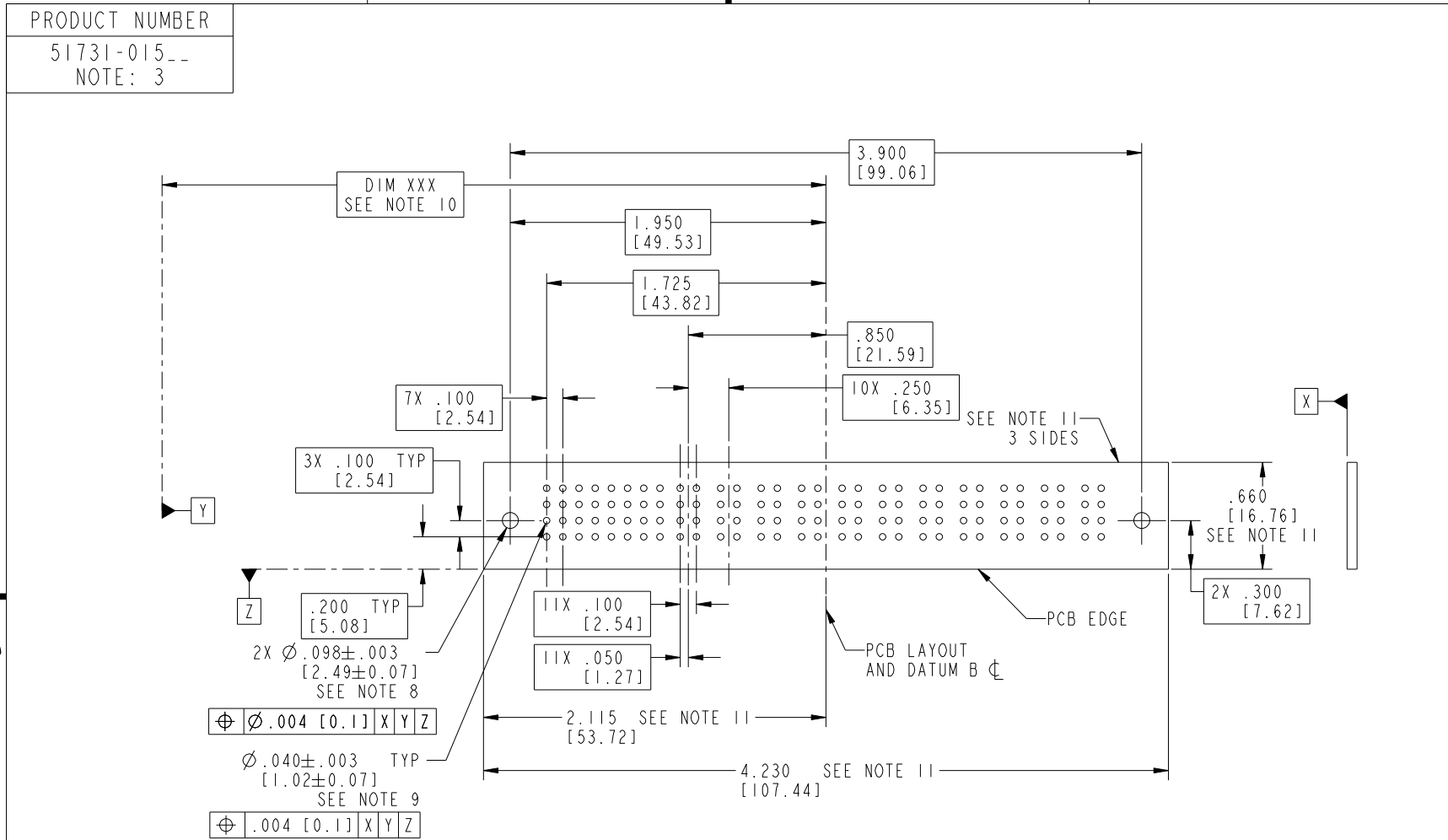

RECOMMENDED PCB LAYOUT

mat'l code		SEE NOTE 2		tolerances unless otherwise specified		CUSTOMER		 www.fciconnect.com	
lfr	ecn no.	dr	date	linear	.XX±.01/0.X±0.3	COPY		title	
F				angles	.XX±.005/0.XX±0.13	projection		32S + 11P	
				dr	.XXX±.0020/0.XXX±0.051			RIGHT ANGLE SOLDER HEADER	
				enr	0°±2°	INCH/MM		product family	
				enr	T. BRUNGARD 01/21/03	scale		PwrBlade	
				enr	M. MOSTOLLER 01/21/03	1:1		code	
				chr	M. MOSTOLLER 01/21/03			213	
				appd	M. MOSTOLLER 01/21/03			sheet	
sheet index		revision sheet						3 of 4	
								A 51731-015	

cage code 22556

Pro/E

PDM: Rev:F

STATUS: Released

Printed: Aug 17, 2007

PRODUCT NUMBER

51731-015__
NOTE: 3

NOTES:

1. DIMENSIONS AND TOLERANCES ARE IN ACCORDANCE WITH ASME Y14.5M, 1994 UNLESS OTHERWISE SPECIFIED.

CONNECTOR NOTES:

- 2. HOUSING MATERIAL: UL 94 V-0 GLASS FILLED
HIGH-TEMP THERMOPLASTIC
POWER CONTACT MATERIAL: COPPER ALLOY
SIGNAL PIN MATERIAL: COPPER ALLOY
- 3. 51731-015;51731-015LF;51731-015GLF PLATING SPEC. SEE PRINT:10064183
- 4. MANUFACTURER'S NAME, P/N, AND DATE CODE TO APPEAR ON THIS SURFACE.
- 5. PRODUCT SPECIFICATION GS-12-149.
APPLICATION SPECIFICATION BUS-20-067.
- 6. PACKAGED IN TRAYS.

PCB NOTES:

- 7. ALL HOLE DIAMETERS ARE FINISHED HOLE SIZE.
- 8. MOUNTING HOLES, WHERE APPLICABLE, ARE UNPLATED.
- 9. $\varnothing .0453 \pm .0010$ [1.151 \pm 0.025] DRILLED HOLES PLATED WITH .0003 [0.008] MIN SnPb OR Sn OVER .001 [0.03] TO .003 [0.08] Cu PLATING TO ACHIEVE $\varnothing .040 \pm .003$ [1.02 \pm .07] HOLE.
- 10. "DIM XXX" TO BE DETERMINED BY THE CUSTOMER.
- 11. CONNECTOR KEEP-OUT ZONE.

mat'l code		SEE NOTE 2		tolerances unless otherwise specified		CUSTOMER		FCI	
ltr	ecn no.	dr	date	linear	.XX±.01/0.X±0.3	projection	www.fciconnect.com		
F					.XX±.005/0.XX±0.13		title 32S + IIP		
				angles	.XXX±.0020/0.XXX±0.051		RIGHT ANGLE SOLDER HEADER		
				dr	T. BRUNGARD 01/21/03		product family PwrBlade		code
				enrg	M. MOSTOLLER 01/21/03		size	dwg no	213
				chr	M. MOSTOLLER 01/21/03	scale	A 51731-015		sheet
				appd	M. MOSTOLLER 01/21/03	1:1			4 of 4
sheet index	revision sheet								

Tous droits strictement réservés. Reproduction ou communication a des tiers interdite sous quelque forme que ce soit sans autorisation écrite du propriétaire. Propriété de c FCI. Droits de reproduction FCI.



All rights strictly reserved. Reproduction or issue to third parties in any form whatever is not permitted without written authority from the proprietor. Property of FCI. Copyright FCI.